

EverGuard WR Offset Gutter

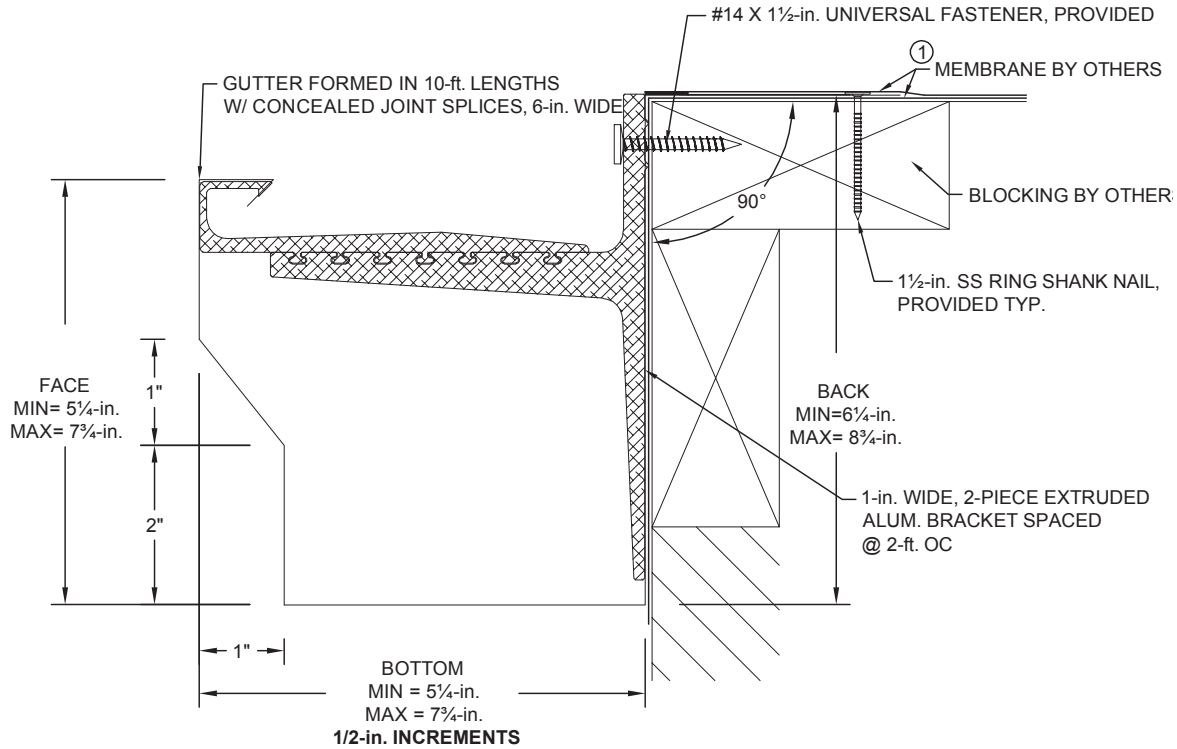

Order Specification Form



① Coordinate installation with membrane manufacturer.

QUANTITY	CAP MATERIAL	THICKNESS	COLOR	CAP FINISH
___ Total LF	<input type="checkbox"/> Aluminum	<input type="checkbox"/> 0.040	<input type="checkbox"/> Statuary Bronze (A-01)	<input type="checkbox"/> Mill Finish
___ Miters (___Outside, ___Inside)	<input type="checkbox"/> Galvanized	<input type="checkbox"/> 0.050	<input type="checkbox"/> Bone White (A-23)	<input type="checkbox"/> Prefinished Kynar
___ End Caps (___Left, ___Right)	<input type="checkbox"/> Stainless Steel	<input type="checkbox"/> 0.063	<input type="checkbox"/> Concord Cream (A-02)	<input type="checkbox"/> Post Finished Kynar
___ Radius LF	<input type="checkbox"/> _____	<input type="checkbox"/> 24GA	<input type="checkbox"/> Medium Bronze (A-05)	<input type="checkbox"/> Prefinished Anodized
___ Expansion Joints	ACCESSORY TYPE	<input type="checkbox"/> 22GA	<input type="checkbox"/> Sandstone (A-06)	<input type="checkbox"/> Post Finished Anodized
___ Special Corners	<input type="checkbox"/> Welded	<input type="checkbox"/> _____	<input type="checkbox"/> Dove Gray (A-09)	<input type="checkbox"/> _____
	<input type="checkbox"/> Metal-Lok		<input type="checkbox"/> Sierra Tan (A-26)	
			<input type="checkbox"/> _____	

0.063 prefinished Kynar is only available in Statuary Bronze, Medium Bronze, Sandstone, Dove Gray, Ascot White, Forest Green & Bone White.
22 GA. prefinished Kynar is only available in Statuary Bronze, Medium Bronze, Shale Gray, Forest Green & Bone White.

APPROVALS: Contact manufacturer for verification of test report data on your project.		CUSTOMER APPROVAL	
 		<input type="checkbox"/> Approved for Fabrication <input type="checkbox"/> Approved with Changes <input type="checkbox"/> Not Approved	
		Authorized Customer Signature _____ Title _____ Date _____	
Job Name:	Customer:	By:	
Job #:	Representative:	Date:	
Location:	Architect:	Sheet of	



EverGuard WR Offset Gutter

STANDARD COLORS - Other Colors Available

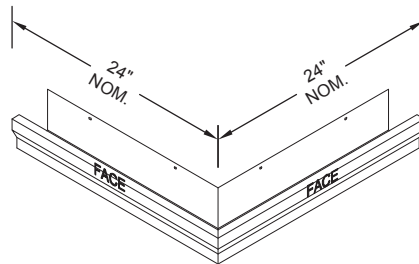
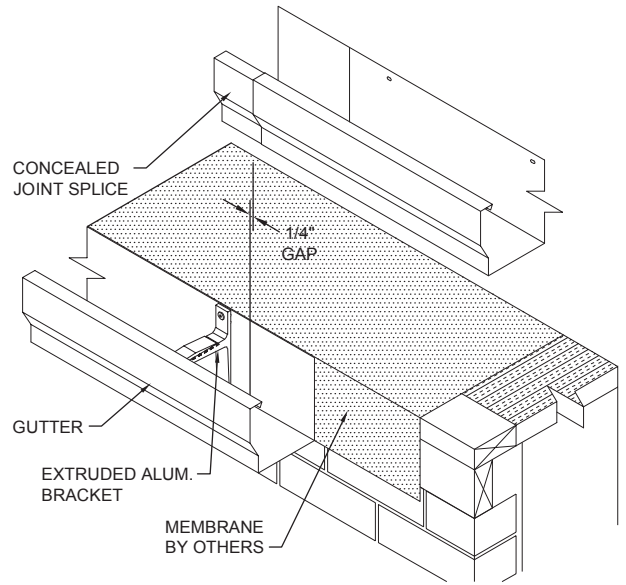

OUTSIDE MITER

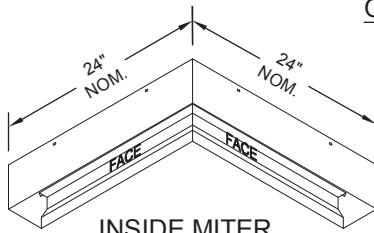

INSIDE MITER

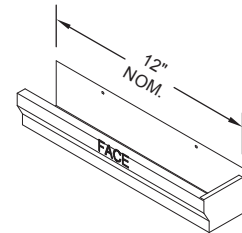

END CAP

RIGHT HAND SHOWN

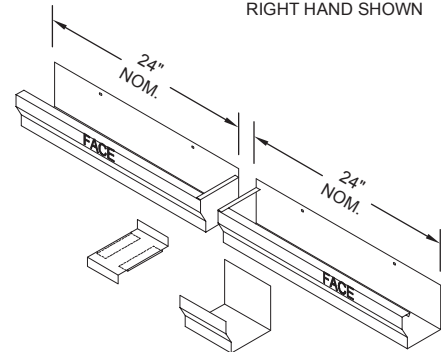

EXPANSION JOINT

(IF REQUIRED)

Standard coping miter leg lengths are 24-in. Nominal
Standard fascia miter angle is 90°
For special miter requirements, attach sketches or consult manufacturer for assistance.